

Top View

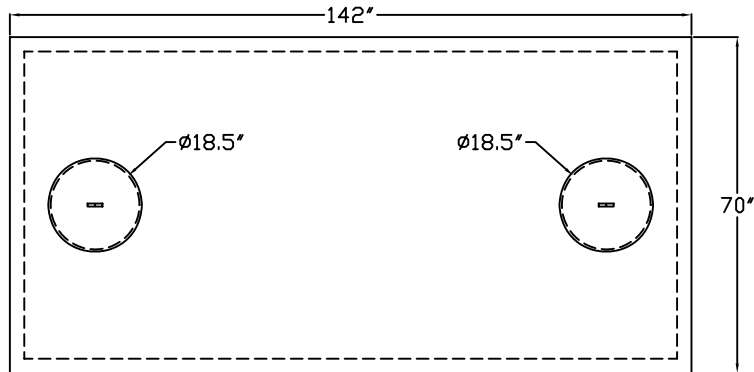

End View

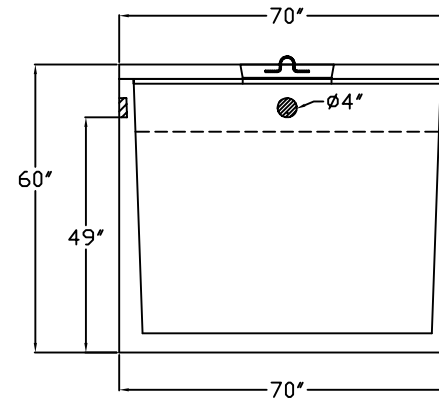

Side View

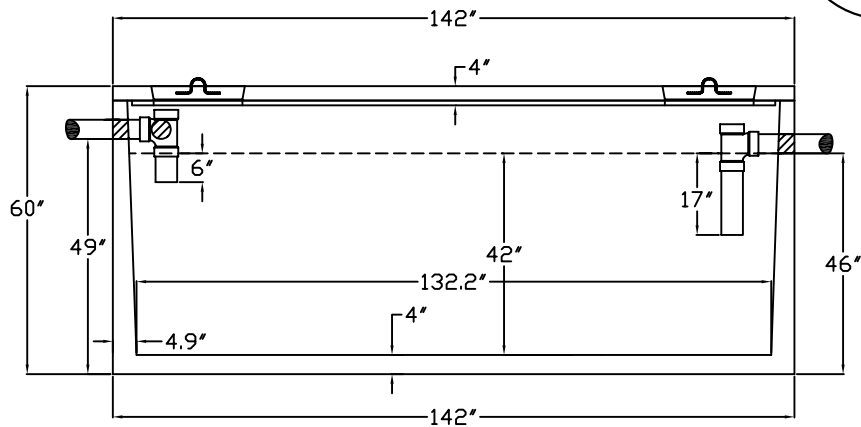

Butyl Sealant:  
ASTM-C-990 Compliant

Baffle View

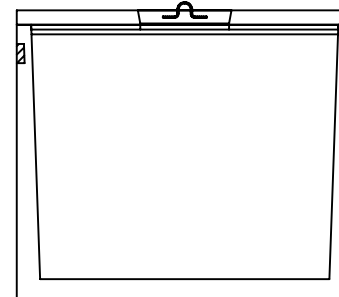

**Specifications**

**Concrete:** 5,000 psi minimum strength (28 day)

**Reinforcing:** Primary reinforcement will be #3 rebar (Grade 60) rebar that will reinforce the top, side, baffle wall, and bottom. The rebar will be on 18" centers (width and length) in the walls, bottom, and top. All splices will be overlapped six inches.

**Risers:** All risers, if required, will be watertight and have a lid that will support a 2500 lb. wheel load.

**Sealant:** Sealant used in the seam of the tank will meet or exceed ASTM C990.

**Pipe Penetrations:** Inlet and outlets are fitted with seals that meet or exceed all ASTM C923 specifications manufactured by Polylok and Press-Seal Gasket Corporation.

**Effluent Filter:** All effluent filters, if required, will be a PolyLok PL-68 or other approved filter.

**Inlet / Outlet Baffle:** The inlet and outlet baffle is a 4" sch. 40 sanitary PVC tee. The tee's will extend approximately within 1" of the inside top of the tank.

**Partition Wall:** The partition wall, if present, is poured monolithically.

**Tank Label:** On the end of the tank, above and to the right of the outlet, the company logo and number of gallons will be cast into the tank.

Manufactured by:  
**C.R. Barger & Sons, Inc.**  
238 Mays Valley Road  
Harriman Tn 37748  
Phone 865.882.5860 Fax 865.882.6394  
www.bargerandsons.com

General Notes:  
All vertical measurements are accurate within ± 1 inch on the tank. The lids can be moved and resized if necessary. Written specifications are available upon request.

Tank Type: <b>Septic 1500 Gallon Single Compartment</b>	
Date: <b>4.212005</b>	Approx. Weight: <b>15,000 lbs.</b>
Drawn By: <b>Eric Barger</b>	State: <b>Arkansas</b>