

Top View

- 4" inlet/outlet (standard)
- 2/3 - 1/3 compartment capacity

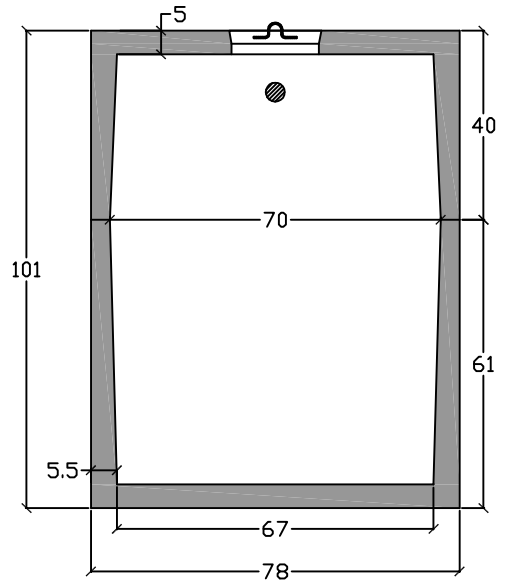

End View

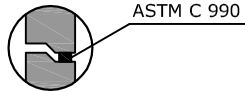
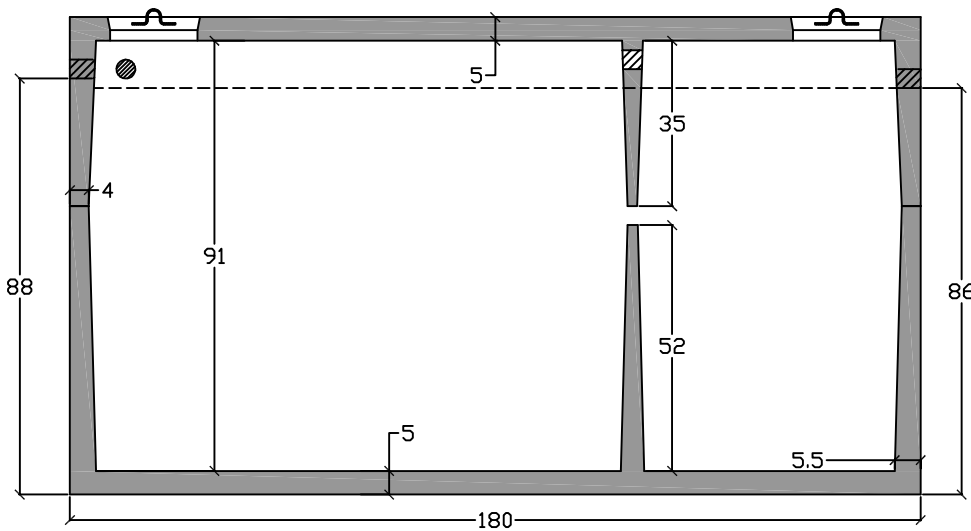

Side View

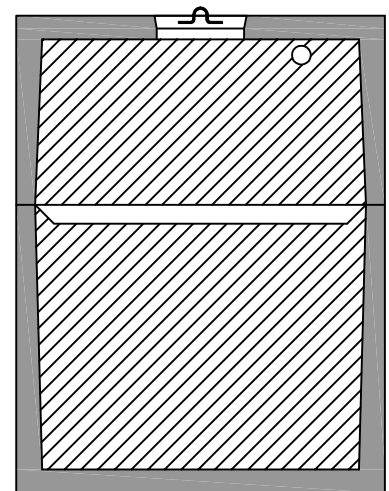

Baffle View

Specifications

Concrete: 5,000 psi minimum strength (28 day)
Reinforcing: Primary reinforcement will be rebar.
Risers: Grade rings and manhole frames and covers sold separately.
Sealant: Sealant used in the seam of the tank will meet or exceed ASTM C990.
Pipe Penetrations: Inlet and outlets are fitted with seals that meet or exceed all ASTM C923 specifications.
Partition Wall: The partition wall, if present, is poured monolithically.
Watertight: ASTM C 1227 latest revision. Tank must be tested within 3 working days of delivery.
Drawing: All measurements are accurate within ± 1 inch.

Tank Warranty: When installed in accordance with manufacturer's instructions is warranted against defective materials and/or workmanship for 1 year from the date of delivery to the project site. Should a defect appear within the warranty period, C. R. Barger & Sons, Inc. will supply a new tank in replacement thereof. C. R. Barger & Sons, Inc. liability is limited to the value of the tank itself and specifically excludes the cost of installation and/or removal and consequential damages. Failure to comply with C. R. Barger & Sons, Inc. installation procedures and general notes will void warranty.

Installation: The tank hole is not to be more than 18 in. longer and wider than the tank. There shall be a minimum of 6" of 3/4" stone bedding. Do not install across path of vehicles or heavy equipment. This tank is designed for one hundred fifty pounds per square foot (150 lb/ft²) uniform loading on the top of the tank with a max backfill cover of 36" and a minimum of 6".



Septic Tank 4000 Gallon

C.R. Barger & Sons, Inc.
 P.O. Box 370 - Kingston TN 37763
 Phone 888.882.5860 - BargerAndSons.com

Date: 5.102010

Drawn By: Eric Barger

Approx. Weight:

36,000 lbs.