

Top View

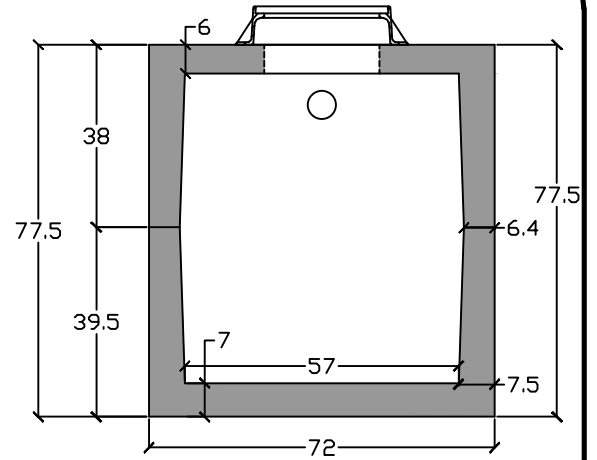

End View

- ASTM C 1613 compliant
- HS20 traffic rated
- 4" inlet/outlet (standard), larger sizes must be specified
- 6" PVC 90 in baffle wall
- 2/3 - 1/3 compartment capacity

ASTM C 990 Butyl Sealant

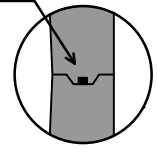

24" clear opening, H20 Manhole Frame and Cover. Lid is labeled "Grease". Please specify vented or non-vented lid.

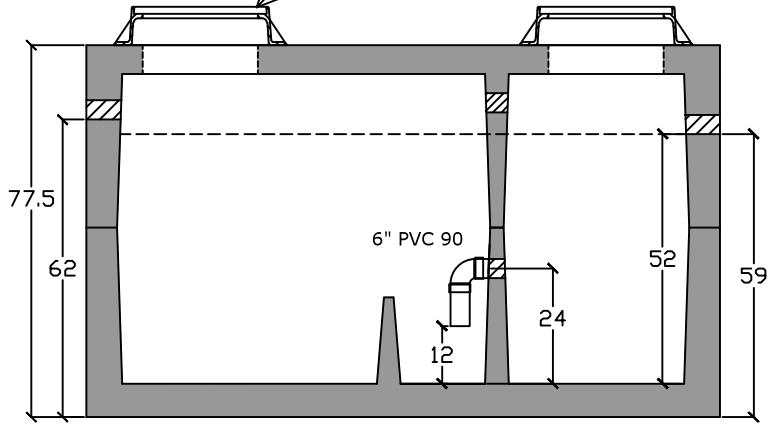

Side View

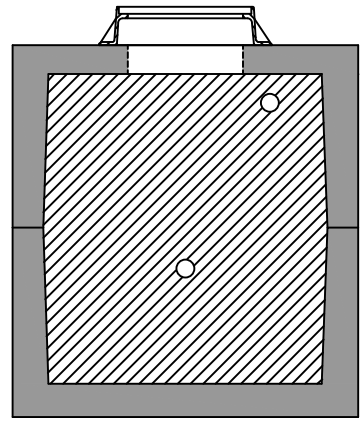

Baffle View

Specifications

Concrete: 5,000 psi minimum strength (28 day)
Reinforcing: Primary reinforcement will be rebar.
Risers: Grade rings and manhole frames and covers sold separately.
Sealant: Sealant used in the seam of the tank will meet or exceed ASTM C990.
Pipe Penetrations: Inlet and outlets are fitted with seals that meet or exceed all ASTM C923 specifications.
Partition Wall: The partition wall, if present, is poured monolithically.
Watertight: ASTM C 1227 latest revision. Tank must be tested within 3 working days of delivery.
Drawing: All measurements are accurate within ± 1 inch.

Installation: The tank hole is not to be more than 18 in. longer and wider than the tank. There shall be a minimum of 6" of 3/4" stone bedding. This tank is designed for HS20 traffic loads and with a max backfill cover of 8" and a minimum of 6".



**Grit Tank HS20 1500 Gallon
City of Morristown, TN**

C.R. Barger & Sons, Inc.
 P.O. Box 370 - Kingston TN 37763
 Phone 888.882.5860 - BargerAndSons.com

Date: 7.092012 Drawn By: Eric Barger Approx. Weight: 26,000 lbs.