

Top View

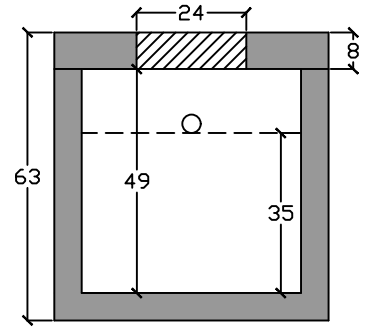

End View

- 4" inlet/outlet (standard)

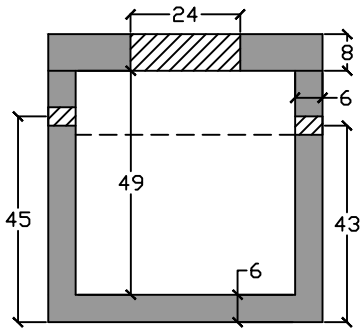

Side View

Specifications

Concrete: 5,000 psi minimum strength (28 day)
Reinforcing: Primary reinforcement will be rebar.
Risers: Grade rings and manhole frames and covers sold separately.
Sealant: Sealant used in the seam of the tank will meet or exceed ASTM C990.
Pipe Penetrations: Inlet and outlets are fitted with seals that meet or exceed all ASTM C923 specifications.
Partition Wall: The partition wall, if present, is poured monolithically.
Watertight: ASTM C 1227 latest revision. Tank must be tested within 3 working days of delivery.
Drawing: All measurements are accurate within ± 1 inch.

Tank Warranty: See Terms and Conditions.

BARGER PRECAST

C.R. Barger & Sons, Inc.
P.O. Box 370 - Kingston TN 37763
Phone 888.882.5860 - BargerAndSons.com

Installation: The tank hole is not to be more than 18 in. longer and wider than the tank. There shall be a minimum of 6" of 3/4" stone bedding. This tank is designed for HS20 traffic loads and with a max backfill cover of 8' and a minimum of 6".

Oil Water Separator 350 Gallon Traffic Rated

Date: 11.212022

Drawn By: Eric Barger

Approx. Weight: 9,800 lbs.